

IG 23 with S Housing and HE Feedback

Model Numbering

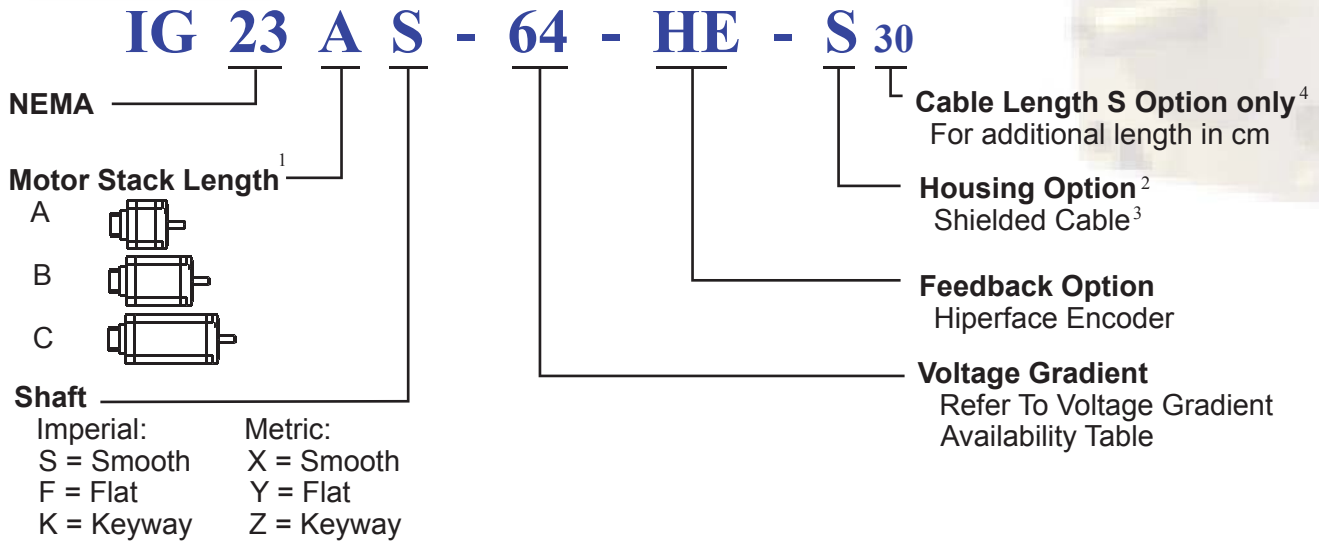

1. Refer to Dimensions for the exact length and shaft options
2. All the motors are rated IP64 and by adding front shaft seal it's rating becomes IP65
3. The motor comes with 18 inches (46 cm) shielded cable
4. Blank For Standard length (18 inches = 46 cm)

Voltage Gradient

Voltage Constant K_E (V/kRPM)	8	11	16	22	32	44	64	88	130	180
Frame Size IG 23										

Performance Curves

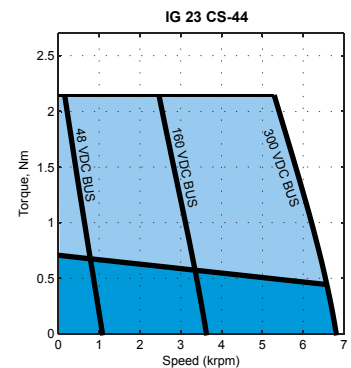
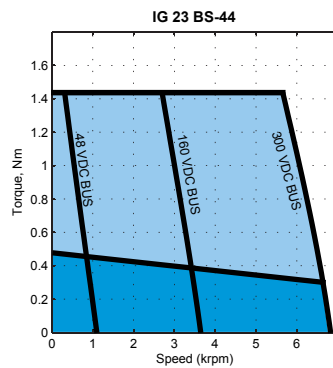
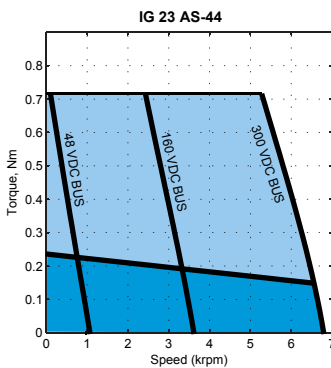

Contact factory for torque-speed curves of other motors

Feb, 16, 06

IG 23 with S Housing and HE Feedback

Electrical Specifications

NEMA 23																		
Index	Model Number	Weight		Torque Constant (Peak) (L2L)		Voltage Constant	Cont. Stall Torque		Cont. stall current	Peak Stall Torque		Peak Stall Current	Max BEMF (Peak) (L2L)	Max Speed	L-to-L Resistance	L-to-L Inductance	Rotor Inertia	
		W		K_T		K_E	T_{cs}		I_{cs}	T_P		I_P	U_{max}	n_{max}	R	L	J	
		kg	lb	Nm/A	lb-in/A	V/krpm	Nm	lb-in	A	Nm	lb-in	A	V	rpm	Ohms	mH	kg-cm ²	lb-in-sec ²
13	IG 23 AS - 8	0.62	1.37	0.09	0.78	8.00	0.24	2.12	2.72	0.72	6.37	8.16	64.00	8000	0.60	0.72	0.30	0.00
14	IG 23 BS - 8	0.96	2.12	0.09	0.78	8.00	0.48	4.25	5.44	1.44	12.75	16.32	64.00	8000	0.28	0.35	0.60	0.00
15	IG 23 CS - 8	1.20	2.65	0.09	0.78	8.00	0.72	6.37	8.16	2.16	19.12	24.48	64.00	8000	0.21	0.24	0.90	0.00
16	IG 23 AS - 11	0.62	1.37	0.12	1.07	11.00	0.24	2.12	1.98	0.72	6.37	5.94	88.00	8000	1.40	1.90	0.30	0.00
17	IG 23 BS - 11	0.96	2.12	0.12	1.07	11.00	0.48	4.25	3.96	1.44	12.75	11.87	88.00	8000	0.55	0.75	0.60	0.00
18	IG 23 CS - 11	1.20	2.65	0.12	1.07	11.00	0.72	6.37	5.94	2.16	19.12	17.81	88.00	8000	0.45	0.60	0.90	0.00
19	IG 23 AS - 16	0.62	1.37	0.18	1.56	16.00	0.24	2.12	1.36	0.72	6.37	4.08	128.00	8000	2.65	3.20	0.30	0.00
20	IG 23 BS - 16	0.96	2.12	0.18	1.56	16.00	0.48	4.25	2.72	1.44	12.75	8.16	128.00	8000	1.00	1.35	0.60	0.00
21	IG 23 CS - 16	1.20	2.65	0.18	1.56	16.00	0.72	6.37	4.08	2.16	19.12	12.24	128.00	8000	0.78	1.10	0.90	0.00
22	IG 23 AS - 22	0.62	1.37	0.24	2.15	22.00	0.24	2.12	0.99	0.72	6.37	2.97	176.00	8000	5.90	9.30	0.30	0.00
23	IG 23 BS - 22	0.96	2.12	0.24	2.15	22.00	0.48	4.25	1.98	1.44	12.75	5.94	176.00	8000	2.20	2.90	0.60	0.00
24	IG 23 CS - 22	1.20	2.65	0.24	2.15	22.00	0.72	6.37	2.97	2.16	19.12	8.90	176.00	8000	1.80	2.40	0.90	0.00
25	IG 23 AS - 32	0.62	1.37	0.35	3.12	32.00	0.24	2.12	0.68	0.72	6.37	2.04	256.00	8000	15.20	18.20	0.30	0.00
26	IG 23 BS - 32	0.96	2.12	0.35	3.12	32.00	0.48	4.25	1.36	1.44	12.75	4.08	256.00	8000	6.20	7.10	0.60	0.00
27	IG 23 CS - 32	1.20	2.65	0.35	3.12	32.00	0.72	6.37	2.04	2.16	19.12	6.12	256.00	8000	4.60	5.70	0.90	0.00
28	IG 23 AS - 44	0.62	1.37	0.49	4.29	44.00	0.24	2.12	0.49	0.72	6.37	1.48	352.00	8000	28.50	35.60	0.30	0.00
29	IG 23 BS - 44	0.96	2.12	0.49	4.29	44.00	0.48	4.25	0.99	1.44	12.75	2.97	352.00	8000	11.50	14.10	0.60	0.00
30	IG 23 CS - 44	1.20	2.65	0.49	4.29	44.00	0.72	6.37	1.48	2.16	19.12	4.45	352.00	8000	9.10	12.30	0.90	0.00
31	IG 23 AS - 64	0.62	1.37	0.71	6.25	64.00	0.24	2.12	0.34	0.72	6.37	1.02	512.00	8000	67.20	80.90	0.30	0.00
32	IG 23 BS - 64	0.96	2.12	0.71	6.25	64.00	0.48	4.25	0.68	1.44	12.75	2.04	512.00	8000	26.90	33.10	0.60	0.00
33	IG 23 CS - 64	1.20	2.65	0.71	6.25	64.00	0.72	6.37	1.02	2.16	19.12	3.06	512.00	8000	21.30	27.60	0.90	0.00
34	IG 23 AS - 88	0.62	1.37	0.97	8.59	88.00	0.24	2.12	0.25	0.72	6.37	0.74	704.00	8000	107.00	134.50	0.30	0.00
35	IG 23 BS - 88	0.96	2.12	0.97	8.59	88.00	0.48	4.25	0.49	1.44	12.75	1.48	704.00	8000	43.30	54.50	0.60	0.00
36	IG 23 CS - 88	1.20	2.65	0.97	8.59	88.00	0.72	6.37	0.74	2.16	19.12	2.23	704.00	8000	35.80	45.20	0.90	0.00
37	IG 23 AS - 130	0.62	1.37	1.43	12.69	130.00	0.24	2.12	0.17	0.72	6.37	0.50	1,040.00	8000	170.20	212.50	0.30	0.00
38	IG 23 BS - 130	0.96	2.12	1.43	12.69	130.00	0.48	4.25	0.33	1.44	12.75	1.00	1,040.00	8000	68.50	86.84	0.60	0.00
39	IG 23 CS - 130	1.20	2.65	1.43	12.69	130.00	0.72	6.37	0.50	2.16	19.12	1.51	1,040.00	8000	56.70	71.80	0.90	0.00
40	IG 23 AS - 180	0.62	1.37	1.98	17.57	180.00	0.24	2.12	0.12	0.72	6.37	0.36	1,440.00	8000	307.40	406.50	0.30	0.00
41	IG 23 BS - 180	0.96	2.12	1.98	17.57	180.00	0.48	4.25	0.24	1.44	12.75	0.73	1,440.00	8000	131.00	166.10	0.60	0.00
42	IG 23 CS - 180	1.20	2.65	1.98	17.57	180.00	0.72	6.37	0.36	2.16	19.12	1.09	1,440.00	8000	101.00	136.70	0.90	0.00

L2L: Line-to-Line

IG 23 with S Housing and HE Feedback

Motor Drawing

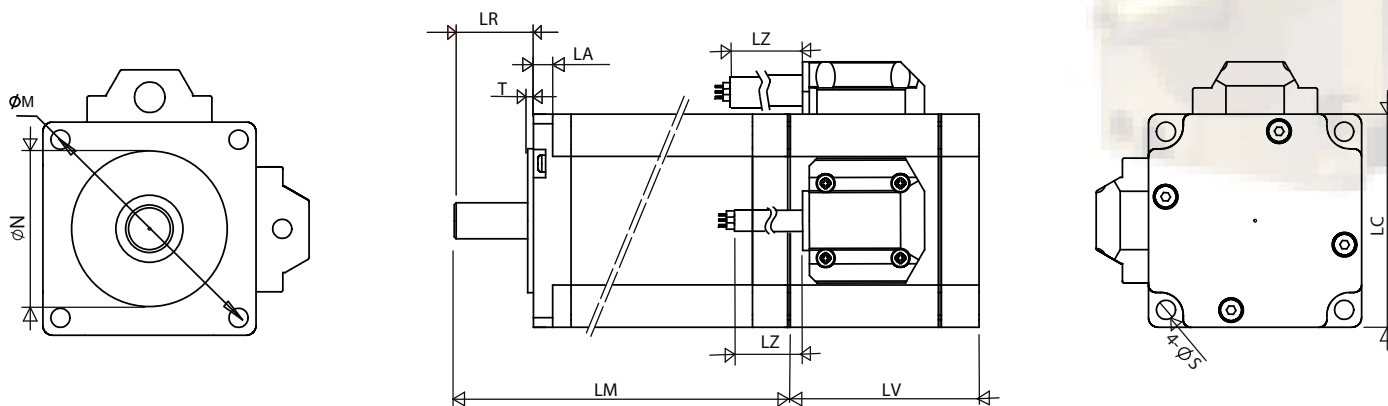

FRONT SHAFT OPTIONS
 (1) SMOOTH SHAFT, AS SHOWN IN THE VIEWS
 (2) KEYWAY SHAFT
 (3) FLAT SHAFT

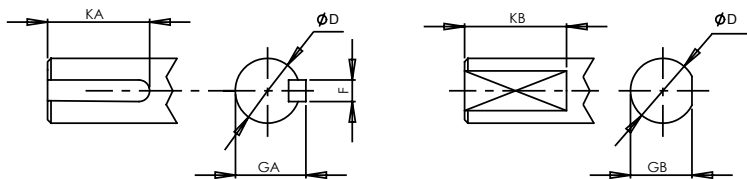

NOTE:
 THE MOTOR IS RATED IP64 AND BY ADDING FRONT
 SHAFT SEAL IT'S RATING BECOMES IP65

Units: inches (mm)

IG		LM	LV	LA	T	LR	LC	LZ	N	S	M
23	A	2.795 (71)	2.00 (50.7)	0.20 (5.1)	0.060 (1.5)	0.825 (21)	2.220 (56.4)	18 (457.2)	1.500 ⁰ _{-0.002} (38.10 ⁰ _{-0.05})	0.200 (5.1)	2.625 (66.68)
	B	3.858 (98)									
	C	4.921 (125)									

Imperial Shaft Option (S/F/K), Units: Inches							Metric Shaft Option (X/Y/Z), Units: mm					
IG	D	F	GA	KA	GB	KB	D	F	GA	KA	GB	KB
23	0.3750 ⁰ _{-0.0005}	0.0938 ⁰ _{-0.001}	0.416 ⁰ _{-0.002}	0.50	0.340 ⁰ _{-0.004}	0.50	10 ⁰ _{-0.013}	3 ⁰ _{-0.025}	11.2 ⁰ _{-0.051}	15	9.0 ⁰ _{-0.1}	15.0

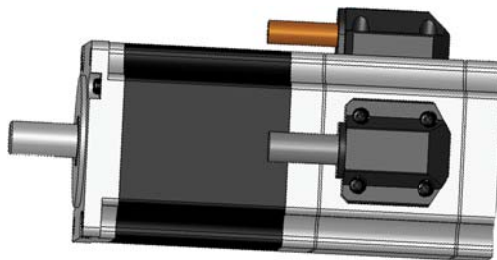

Mar, 20, 06

IG 23 with S Housing and HE Feedback

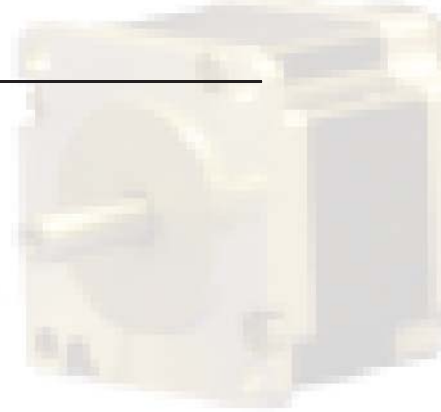

Power Cable Wire Code

Non Brake Power Wiring Diagram

Wire Code	Function
WIRE #1	PHASE U
WIRE #2	PHASE V
WIRE #3	PHASE W
GRN/YEL	Ground
Shield	Shield

SAB CC600CYT, 4 Pins, AWG16/20 (depending on current), 600V, 105C, UL, CE, CSA

Hiperface Encoder

Hiperface Encoder Wiring Diagram

Wire Code	Function
BRN/BLK	REFSIN
BLK/BRN	REFCOS
BLU/BLK	DATA+
BLK/BLU	DATA-
ORN/BLK	+SIN
BLK/ORN	+COS
WHT/BLK	+7~12VDC
BLK/WHT	GND
RED/WHT	Thermistor 1
WHT/RED	Thermistor 2
Shield	Shield

Hiperface Encoder Data SKS 36, SKM 36

Parameter	Values
# of sine/cosine periods per revolution	128
Code type for the absolute value	Binary
Total number of steps (single SKS)	4,096
Output frequency for sine/cosine signals	0 .. 65 kHz
Operating speed (SKS)	12,000 min ⁻¹
Working temperature range	+ 5 ... + 110°C
Operating voltage range	7 ... 12 v
Recommended supply voltage	8 v
Max. operating current, no load	60 mA
Interface signals	
Process data channel=SIN, REFSIN, COS, REFCOS	Analogue, differential
Parameter channel = RS 485	Digital

Mar, 21, 06